

TAV: 1 - CARROZZERIA

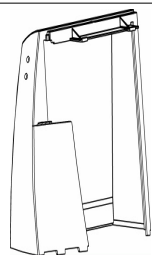

10079935
FIANCATA SX VERN. NUOVA



10079709
VITE PARKER 3.5*16 TORX ZB

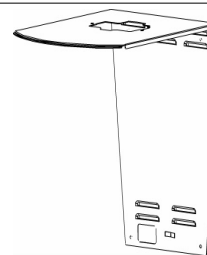

10079707
PANNELLO POSTERIORE INOX

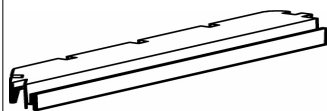

10079706
COPERTURA FIANCATA DX

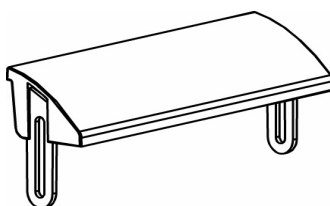

10079712
COPERCHIO SERBATOIO VERN.

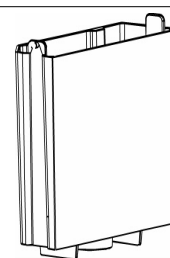

10079713
SERBATOIO ACQUA TAMP.



10088129
COPERCHIO + VALVOLA
SERBATOIO



10079740
GUARNIZIONE SERBATOIO
DI-062

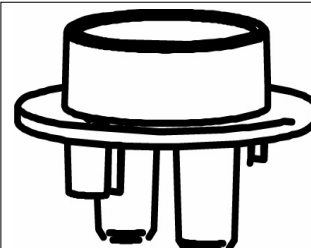

10079716
BASE VALVOLA

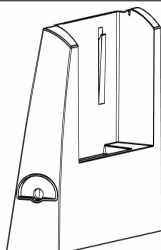

10079936
FIANCATA DX VERN. NUOVA



10079852
GUARNIZIONE PER VALVOLA
SERBATOIO



10079853
O RING M0080-10 8X1 NBR

TAV: 1 - CARROZZERIA



10079714
VALVOLA SCARICO PISTONE

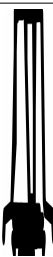

10079783
SPILLO VALVOLA SCARICO

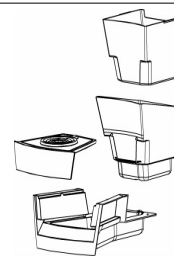

10087285
CASSETTO
RACC.GOCC.ASSEMBLATO GREY

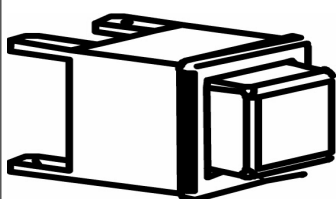

10079939
INT.BIP.LUM.ROSSO 250V 16A
GW L4



10088022
VITE PARKER 3.5X9.5

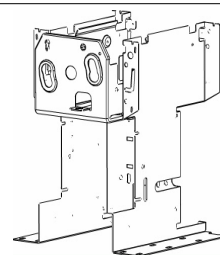

10079746
TELAIO

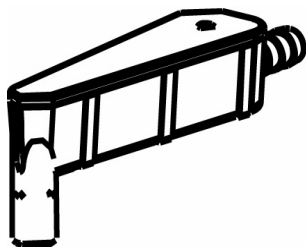

10060104
CAMERA ESPANSIONE
ANTISBUFFO

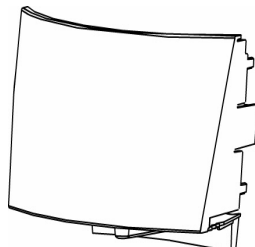

10079877
FRONTALINO STAMPATO



10079749
CAPPUCCIO EROGATORE

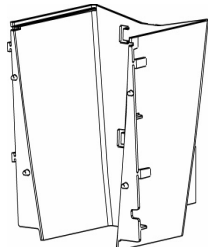

10079937
VANO EROGAZIONE IMQ

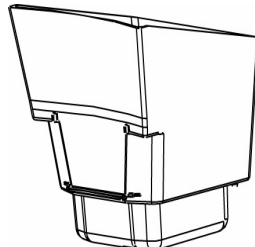

10087243
CASSETTO RACCOGLI
CAPSULE2 VERN.GREY

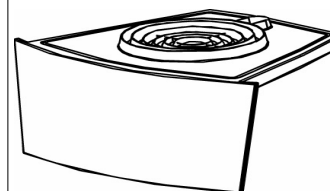

10087249
GRIGLIA POGGIO TAZZA2 VERN
GREY

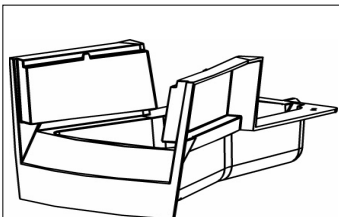

10087255
CASSETTO RACCOGLI GOCCE2
VERN.GREY

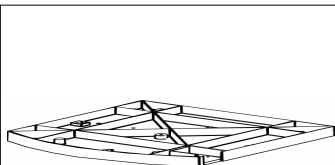

10079756
BASE INFERIORE

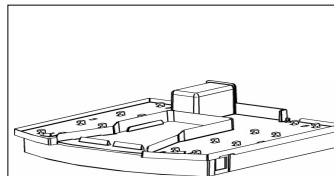

10079755
BASE SUPERIORE



10079758
VITE PARKER 4.2X13

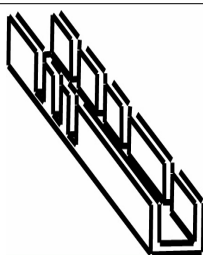

10087231
COPERCHIO CANALINA

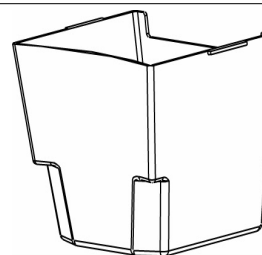

10079875
CASSETTO RACCOGLI CAPSULE
INTERNO

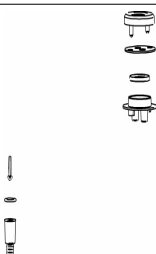

10079858
VALVOLA SERBATOIO
COMPLETA

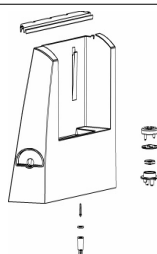

10079836
FIANCATA DX ASSEMBLATA
VERN.

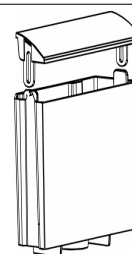

10079851
SERBATOIO COMPLETO

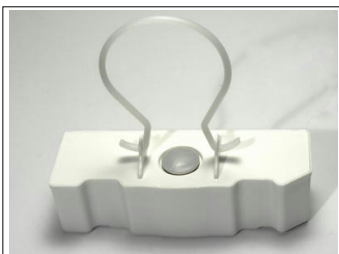

10079688
FILTRO RESINE MAXI X LB1000
IMBALLATO

TAV: 2 - GRUPPO INSERIMENTO CAPSULA

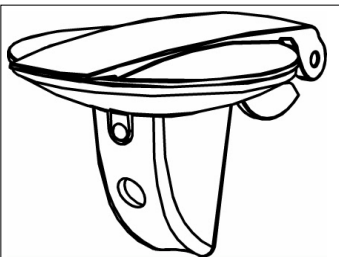

10079881
PORTELLO + SPINTORE
VERN.SCURO

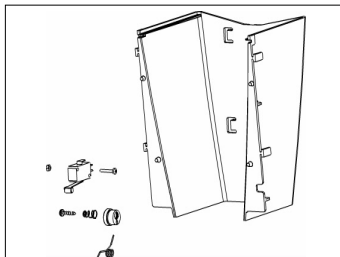

10079861
GRUPPO MICRO VANO
EROGAZIONE

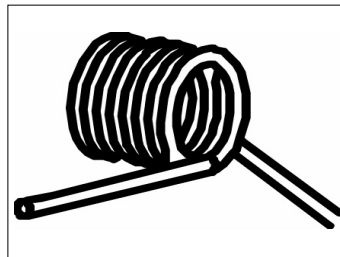

10079777
MOLLA PORTELLO

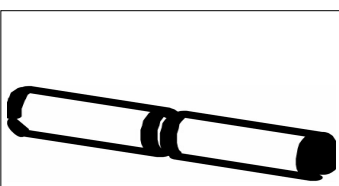

10079778
PERNO PORTELLO

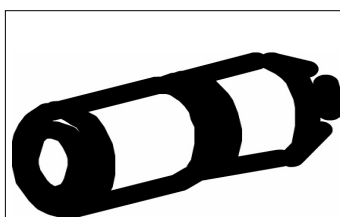

10079780
PERNO GANASCIA

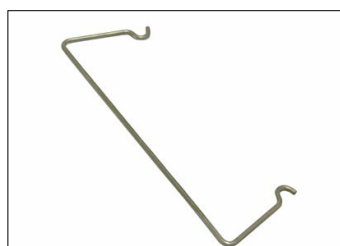

10079781
MOLLA GANASCE

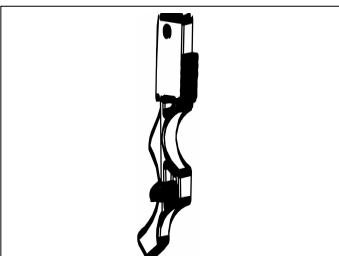

10079784
GANASCIA SX

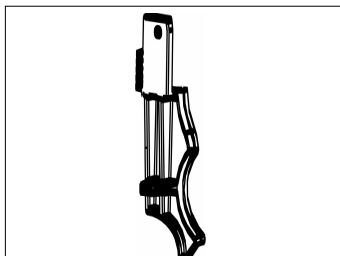

10079782
GANASCIA DX

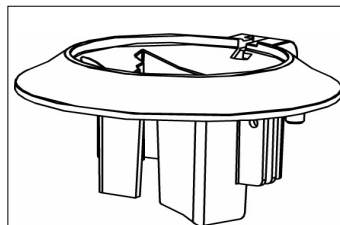

10079882
BASE PORTELLO VERN. SCURO

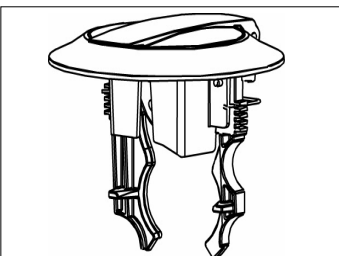

10079837
GRUPPO INSERIM CAPSULA
ASSEMBLATO GREY

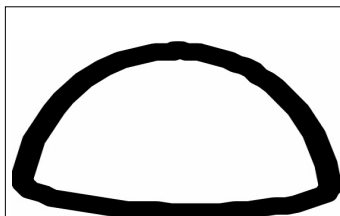

10079785
PIEDINO ADESIVO

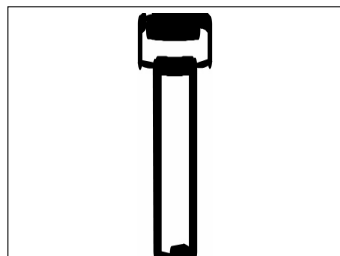

10079708
VITE M4X20

TAV: 2 - GRUPPO INSERIMENTO CAPSULA

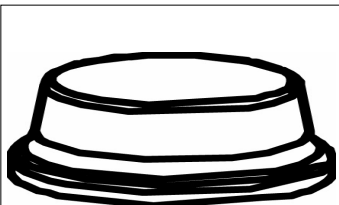

10079757
PIEDINO IN GOMMA



10079941
MICROINTERRUTTORE GW

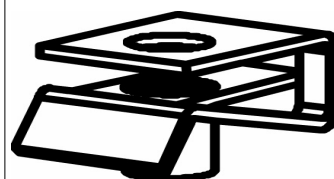

10079704
PIASTRINA DOPPIA

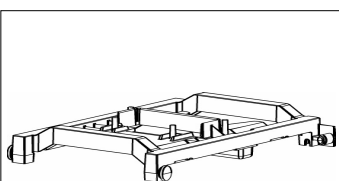

10079942
TELAIO SUPERIORE IMQ



10089021
VITE M3X16

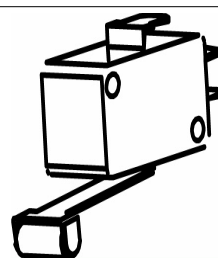

10079772
MICROINTERRUTTORE
CASSETTO



10088028
DADO ESAGONALE ZINCATO M3



10088022
VITE PARKER 3.5X9.5

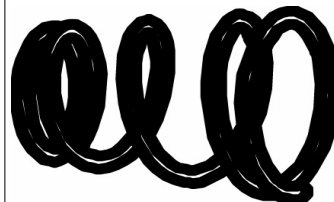

10079773
MOLLA CONICA

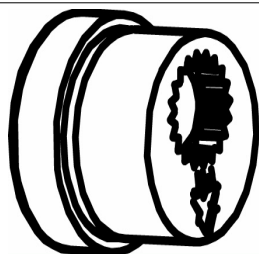

10079774
CAMMA REGOLAZIONE MICRO

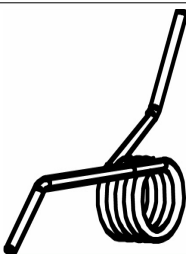

10079775
MOLLA SAGOMATA

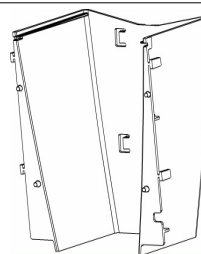

10079937
VANO EROGAZIONE IMQ

TAV: 2 - GRUPPO INSERIMENTO CAPSULA

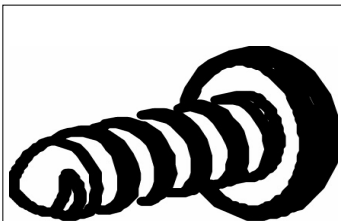

10087282
VITE PARKER 3,5*6,5 TC SP

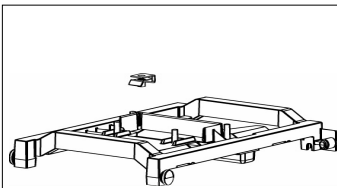

10079860
TELAIO SUPERIORE
ASSEMBLATO

TAV: 3 - GRUPPO IDRAULICO/DISTRIBUTORE



10079894
TUBO SILICONE L= 50 MM D. 4X8



10079764
RONDELLA 4.2*6.8*0.5



10079854
OR 2015 VITON

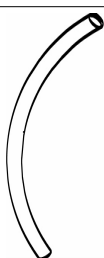

10079899
TUBO SILICONE L= 600 MM D.
4X8



10079944
POMPA 230V 50HZ TIPO EX4 GW

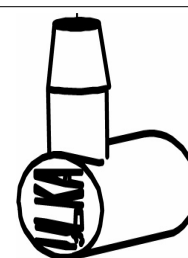

10079766
GOMITO



10079627
RACCORDO 1/8 GAS ATT. RAP.
OTT.



10088180
MOLLETTA X AGGANCIAMENTO RAPIDO

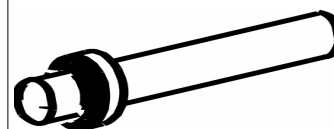

10060981
TUBO TEFL. L = 120 D.4*2 O.
NEW+1TAP+GOM

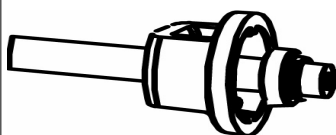

10079723
TUBO TEFLON L=260 MM

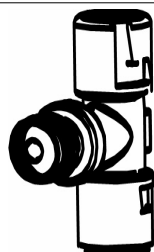

10079909
RACCORDO A TRE VIE IN
OTTONE COMPL. DI OR



10079770
TAPPO AGGANCIAMENTO RAPIDO

TAV: 3 - GRUPPO IDRAULICO/DISTRIBUTORE

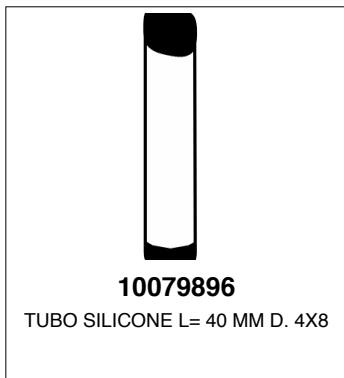
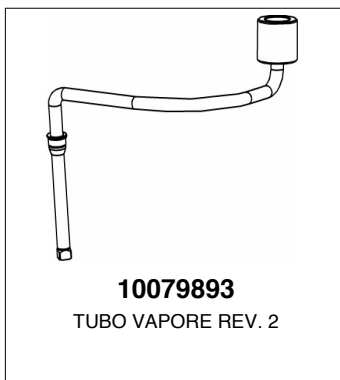
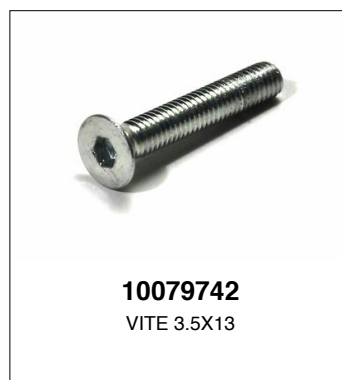
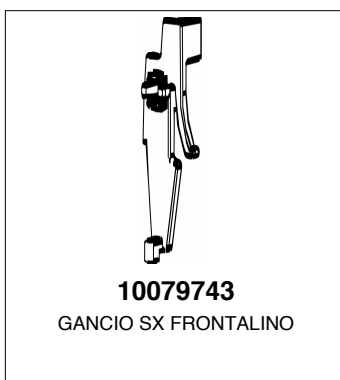
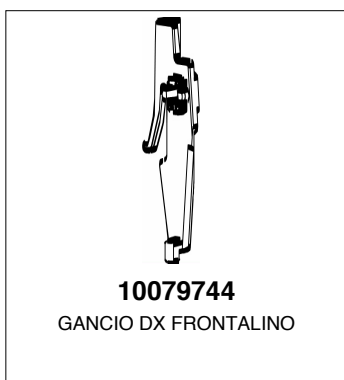

TAV: 3 - GRUPPO IDRAULICO/DISTRIBUTORE



10079898
TUBO SILICONE L= 290 MM D.
4X8



10079736
TUBO SILICONE L=100 MM D.4X8

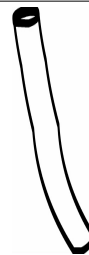

10079738
TUBO SILICONE L=141 MM D.6*3



10079739
TUBO SILICONE L=270 MM D.4X8



10079855
FASCETTA STRINGITUBO



10079887
VITE PARKER 3.5X9.5

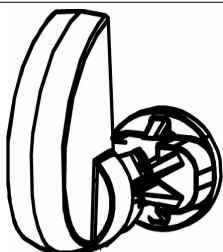

10079763
MANOPOLA + GIUNTO

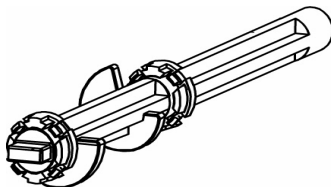

10079790
ALBERO COMANDO
DISTRIBUTORE

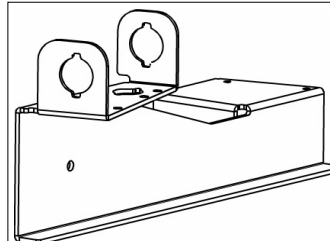

10079788
STAFFA DISTRIBUTORE



10079787
FERMAGLIO RUBINETTO



10060982
TUBO TEFL.L = 220MM D. 4*2 O.
NEW+TAPPO



10088022
VITE PARKER 3.5X9.5

TAV: 3 - GRUPPO IDRAULICO/DISTRIBUTORE



10079941
MICROINTERRUPTORE GW

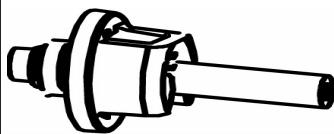

10079725
TUBO TEFLON L=240 MM

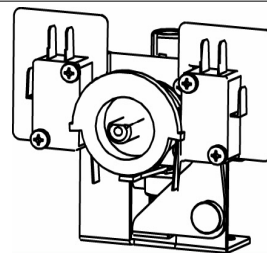

10079786
DISTRIBUTORE ASSEMBLATO

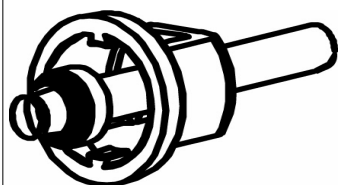

10060983
TUBO TEFL=410 MM D.4*2
O.NEW+TAPPO

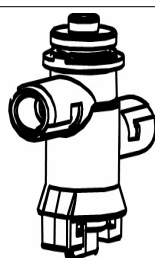

10079792
RUBINETTO ASSEMBLATO

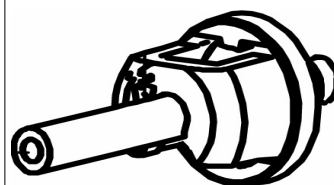

10079726
TUBO TEFLON L=440 MM

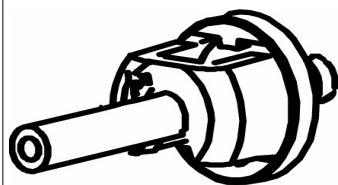

10079728
TUBO TEFLON L=360 MM



10079895
TUBO SILICONE L=150 MM D4x8



10079891
ANELLO X GOMMA POMPA



10079890
VITE PARKER 3.5x6.5

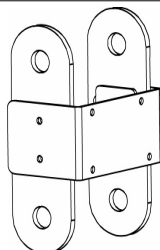

10079889
STAFFA SUPP. POMPE
COMPLETA



10079885
TUBO TEFLON L=90 MM

TAV: 3 - GRUPPO IDRAULICO/DISTRIBUTORE



10079888
GOMMINO SILENZIATORE PER
TUBO TEFLON

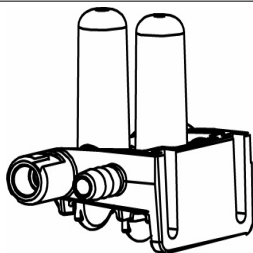

10079886
DISPOSITIVO ANTIVIBRANTE

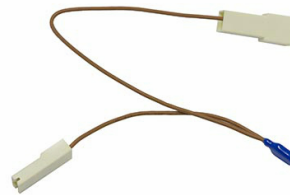

10079293
TERMOPROTETTORE T-120

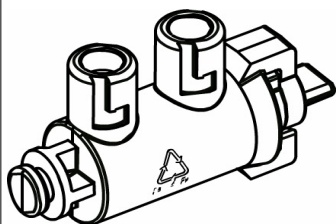

10060082
VALVOLINO ANTIGORGOGLIO + 2
O-RING

TAV: 4 - GRUPPO DISTRIBUTORE



10089021
VITE M3X16

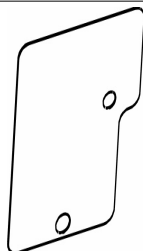

10079947
ISOLANTE



10079941
MICROINTERRUTTORE GW



10088028
DADO ESAGONALE ZINCATO M3

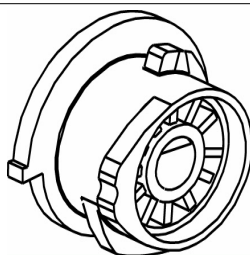

10079929
CAMMA COMANDO
DISTRIBUTORE

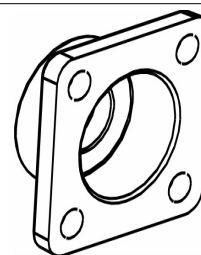

10079922
FLANGIA DISTRIBUTORE

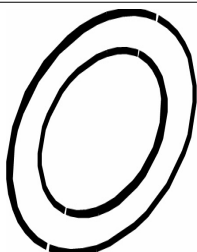

10079927
RONDELLA

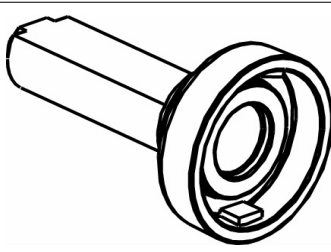

10079923
PERNO COMANDO
DISTRIBUTORE

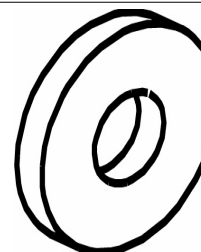

10079930
RONDELLA TEFLON



10079933
MOLLA PER SFERA

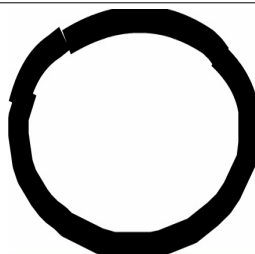

10079934
SFERA

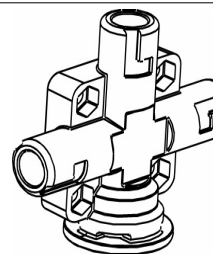

10079921
CORPO DISTRIBUTORE

TAV: 4 - GRUPPO DISTRIBUTORE

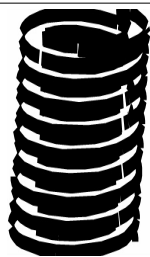

10079926
MOLLA PER SPILLO

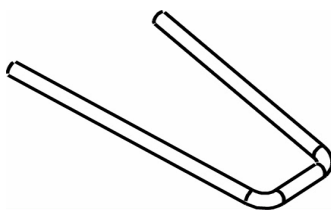

10079932
MOLLA DI CHIUSURA



10079925
SPILLO DISTRIBUTORE



10079931
O RING 2031 VITON

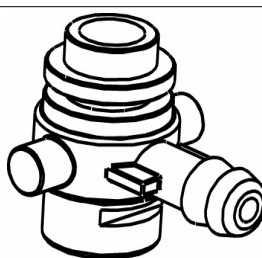

10079924
VALVOLA DISTRIBUTORE ASS.



10079627
RACCORDO 1/8 GAS ATT. RAP.
OTT.

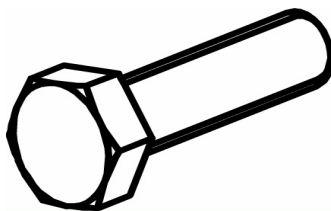

10079822
VITE M5X20

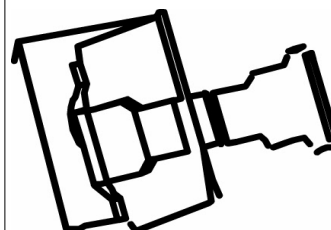

10079825
STAFFA TERMOSTATO BASSA
(130°)



10088314
TERMOSTATO 130°C FASTON
90°

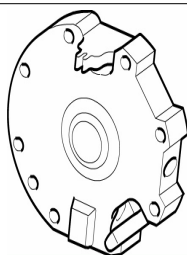

10062640
PIAS.SUP.1/8G.EASYCLEAN

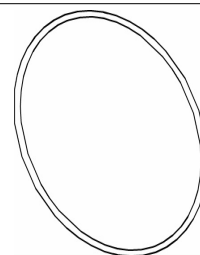

10060988
OR 79X2 SILICONE (COLORE
ROSSO)

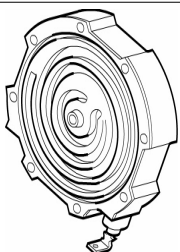

10062641
CALD.PIAST.RES.LB1000EASYC.2
30

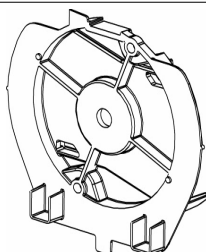

10079910
FLANGIA SUPPORTO CALDAIA
REV.2



10060300
O-RING A SEZIONE MAGGIORATA
PER LB1XXX

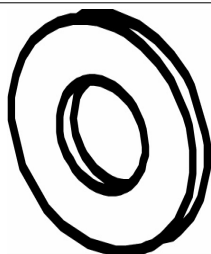

10079911
RONDELLA ISOLANTE

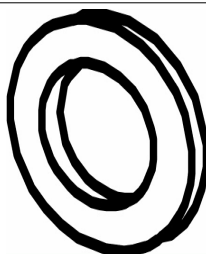

10060984
ROND./5 PIANA NOX



10088180
MOLLETTA X AGGANCIO RAPIDO

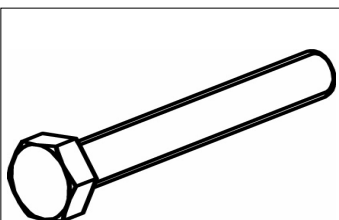

10079823
VITE M5X40

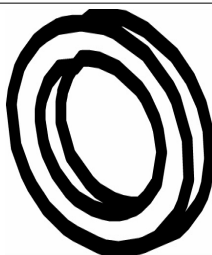

10079821
RONDELLA DENTEL. D.5



10079820
FASTON OTT. MASCHIO DIRITTO
6.3X0.8

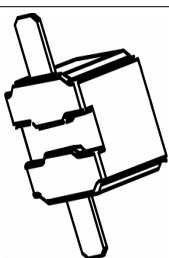

10079850
TERMOSTATO N.C. 100°C
ELECTROVAC



10087020
STAFFA TERMOSTATO ALTA
(100°)

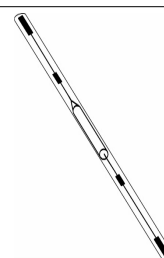

10079904
TERMOFUSIBILE 167° AZZURRO



10088109
STAFFA TERMOFUSIBILE
ZINCATA

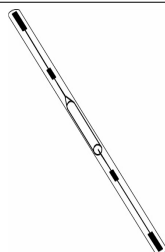

10079905
TERMOFUSIBILE 167° MARRONE

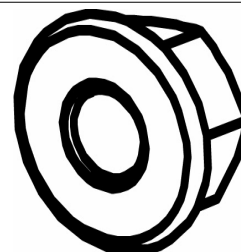

10060974
DADO M5 INOX AUTOFRE.

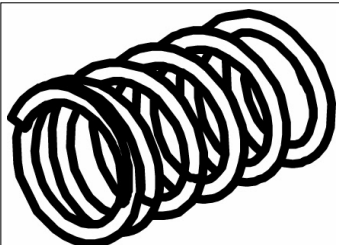

10079810
MOLLA VALVOLINO



10079731
O RING 2131 SILICONE SHA 70



10079730
O RING 4143 SILICONE SHA 70



10079807
PREMICAPSULA



10079808
MOLLA PREMICAPSULA



10079809
PERFORATORE CAPSULA



10079732
O RING 114 EPDM 70 SHA

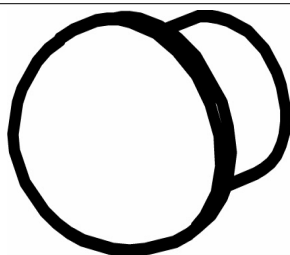

10079811
VALVOLINO PERFORATORE
CAPSULA

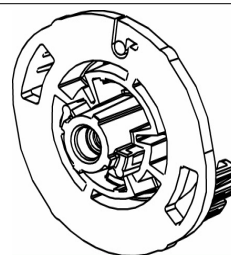

10079813
ANELLO DOCCETTA

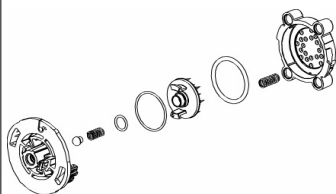

10079863
PREMICAPSULA ASSEMBLATO

TAV: 6 - GRUPPO CALDAIA PARTE IDRAULICA



10079917
TAPPO X CILINDRO REV.2



10079916
MOLLA PISTONE REV.2

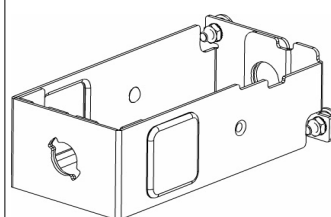

10079913
TELAIO CALD.ASS. REV.2

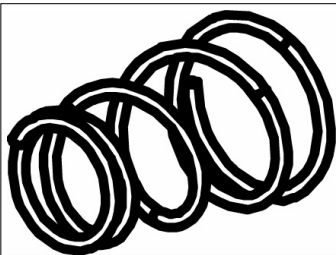

10079773
MOLLA CONICA

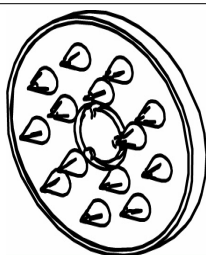

10066943
FILTRO PERFORATORE LB1000
R2 90GL30 BL

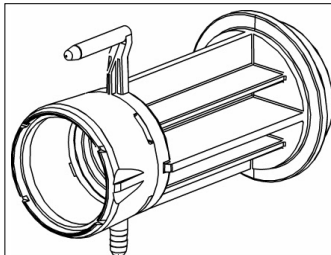

10079915
PISTONE REV.2 (PER LB1000)



10079797
GUARNIZIONE A LABBRO
EPDM70



10079914
CILINDRO REV.2



10079721
TUBO TEFLON L=80 MM

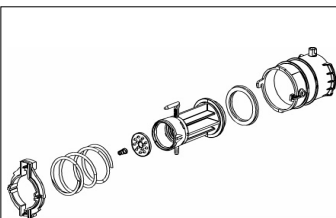

10079918
PISTONE ASS. REV.2

TAV: 7 - COMPONENTI ELETTRICI

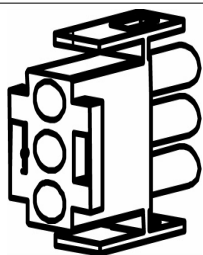

10079829
IMPIANTO ELETTRICO GRUPPO
SPIE 230V



10088226
CONNETTORE



10079711
CAVO ALIMENTAZIONE 230V

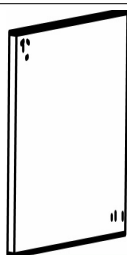

10087016
SCHEDA ELETTRONICA 220V -
120 IMPULSI



10079715
CASSETTO PORTA SCHEDA

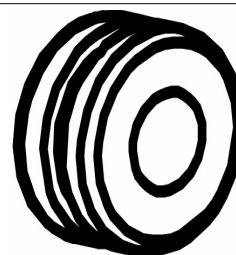

10079901
PASSACAVO

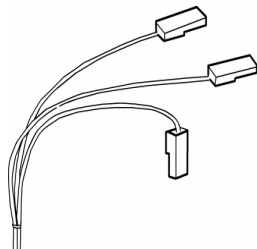

10079946
IMPIANTO ELETTRICO 230V GV



10089051
FASCETTA L=95

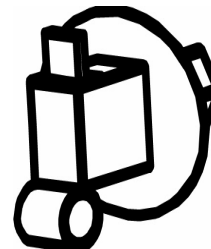

10079832
FASCETTA CON AGGANCIO

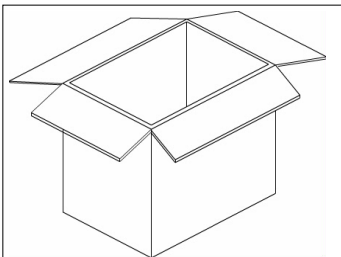

10079844
SCATOLA LB1000 ESTETICA

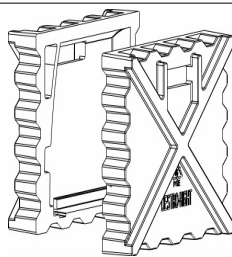

10079760
COPPIE ESPANSO

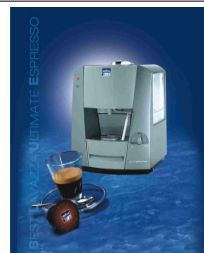

10060099
LIB.IST USA/FRA UL