

BRAUN

Braun Flex Integral 5525 universal

Type 5503

English
Use Instructions
Guarantee
Service Centers

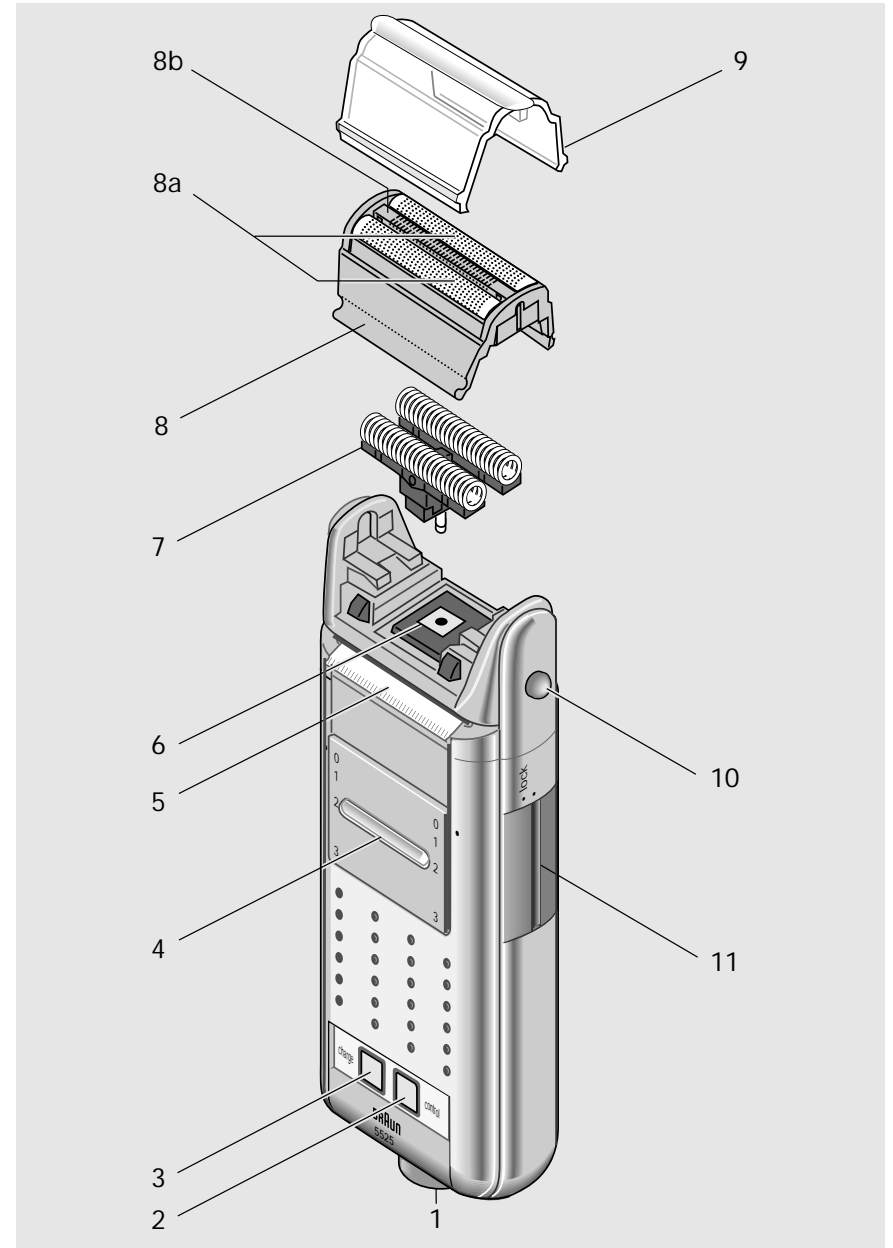

English

Our products are engineered to meet the highest standards of quality, functionality and design. We hope you thoroughly enjoy your new Braun appliance.

Caution

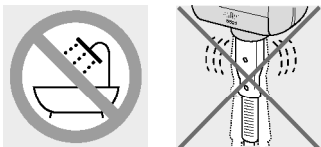

- Do not use the shaver near or over basins filled with water (e. g. bath tubs, showers etc.).
- Periodically check the cord for damages particularly at each end where the cord enters the plug.
- Replace the cord for safety reasons, if it is loose in the shaver socket ①.
- Do not wind the cord around the shaver.

Braun Flex Integral 5525 universal

Pivoting head and triple shaving system

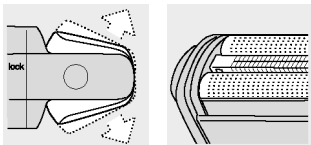

This shaver is equipped with a pivoting head which has a triple shaving system with an integrated longhair cutter. The pivoting head swings to both sides and thus automatically adjusts itself to the contours of your face within its swinging angle. The triple shaving frame ⑧ with its twin foil ⑨ and the integrated longhair cutter ⑩ provide a permanent combination shave.

This means that the integrated longhair cutter cuts the longer hairs, while the twin foil ⑨ together with the cutterblock ⑦ under the foil, provide a close shave – all in one stroke.

Specifications

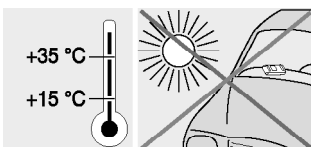

- Wattage: 6 W.
- Voltage range «mains operation»: 100 - 240 V \approx 50 / 60 Hz (automatic adaption of voltage and frequency).
- Voltage range charging (for cordless operation): 12 - 240 V \approx 50 / 60 Hz (automatic adaption of voltage and frequency).
- Lowest charging voltage: 12 V (-) d. c.
- Best environmental temperature range: + 15 °C to + 35 °C. Never expose the shaver to temperatures of less than 0 °C or more than + 40 °C for longer than a few hours.
- This product conforms to the EMC-Requirements as laid down by the Council Directive 89/336/EEC.

For environmental reasons, this appliance is provided with a nickel-hybrid cell unit. This cell unit does not contain any poisonous heavy metals. Nevertheless, in the interest of recycling raw materials please do not dispose of this appliance in the household waste at the end of its useful life. Disposal can take place at a Braun Service Centre or at appropriate collection sites.

Environmentally friendly cell unit



Important note: This appliance is equipped with a special mechanism which has been developed for easy disassembly of the rechargeable cell unit and other components for recycling purposes. Prematurely activating this mechanism by twisting it opens the housing and thereby destroys the appliance. Therefore, the mechanism must not be activated before the end of the useful life of the product. As for any other repair measures, we recommend to have this done by a Braun Service Centre.

Rechargeable cell removal

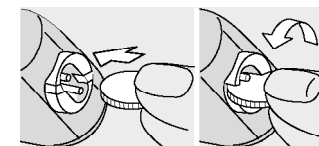

- ① Shaver socket
- ② LCD-display «control»
- ③ LCD-display «charge»
- ④ Switch
- ⑤ Longhair trimmer
- ⑥ Cutterblock base
- ⑦ Duo cutterblock
- ⑧ Triple shaving frame
- ⑨ Twin foil
- ⑩ Integrated longhair cutter
- ⑪ Foil protection cap
- ⑫ Button for releasing the triple shaving frame ⑧
- ⑬ Switch lock

Description

Switch ④

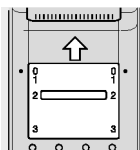



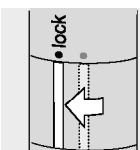

Switch lock

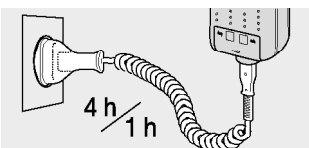



Cordless shaving/charging



- Switch positions:
- 0 = Off (when not in use and always when charging)
 - 1 = Shaving with the twin foil  and the integrated longhair cutter 
 - 2 = Shaving with the pivoting head locked at an angle to permit shaving under the nose or at the hairline
 - 3 = The longhair trimmer  is activated

The shaver was delivered with the switch lock activated (position «● lock»). Push the switch lock  to position «●» before you shave for the first time. To avoid accidentally switching on the shaver, push the switch lock to position «● lock».

When charging the shaver for the first time, connect it to the mains (100 - 240 V) and charge it for 4 hours to full capacity. Then discharge the shaver through normal shaving until the display  flashes. Recharge the shaver for at least 1 hour until the black battery symbol appears in the display .

This charging method preserves the maximum capacity of the cell unit. All subsequent charges will also take only 1 hour (quick charging). The full capacity is reached after several charge/discharge cycles. The shaver automatically adapts to all direct and alternating current voltages (12 - 240 V) and to frequencies of 50 or 60 Hz. Recharging on 12 V (-) in cars or boats, takes approximately 20 hours. The surrounding temperature should not exceed + 25 °C.

A full charge will give up to about 70 minutes of cordless shaving (approximately 20 days based on 3.5 minutes per shave), depending on the thickness of your beard.

The LCD displays  and  show the state of the shaver and the rechargeable cell unit.

The rechargeable cell unit is discharged. The shaver is not in operation.



The cell unit is charged between 0 and 99 %; the shaver is connected to the mains and the plug symbol is visible on the display with a green frame . Should charging be interrupted during the charging phase, the plug symbol flashes on the display, thus reminding you to continue charging.

The shaver is connected to the mains – the plug symbol is visible on the green framed display. After a recharging time of approximately 1 hour, the battery symbol is also visible on the green framed display. The cell unit is recharged to 100 %.

The cell unit is charged between 100 and 20 %; the shaver is not connected to the mains. Whether switched on or off, the battery symbol is visible on the green framed display.

The remaining charge in the cell unit is between 20 and 0 %. The shaver is switched on or off, however, not connected to the mains. The battery symbol flashes on the red framed display  – thus showing the remaining charge – until the cell unit is fully discharged.

In order to maintain the maximum capacity of the rechargeable cell unit, it should be discharged about every 6 months by shaving. Then fully recharged for approximately 4 hours from the mains. Do not keep the shaver connected to the mains for a long period of time (i. e. several weeks).

Connect the shaver to the mains and turn the shaver on (see switch ). If the shaver should not run immediately – because of the discharged cell unit – leave it plugged in with the switch  set to «0», for approximately 1 minute. Thereafter, you can shave with cord plugged into the outlet.

Notice: Shaving directly via the cord on voltages below 100 V (in cars, boats etc.) is not possible.

State of the shaver and cell unit

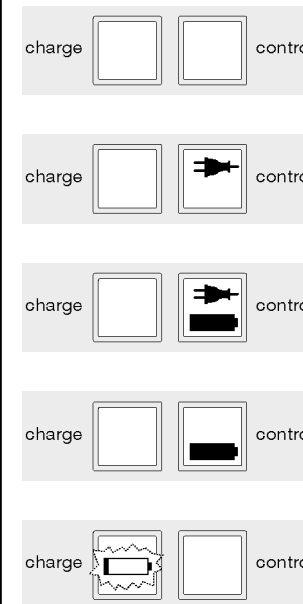

Preserving the cell unit

Shaving with the cord

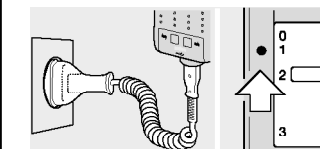

Shaving

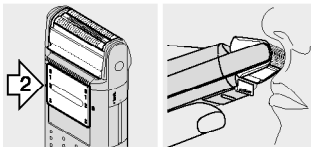
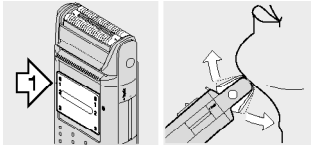
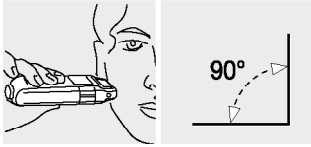

- Take off the foil protection cap ⑨.
- For shaving, push the switch ④ to setting «1».
- Hold the shaver at right angles (90°) to the skin.
- Stretch the skin with your free hand.
- Guide the shaver smoothly against the direction of beard growth, applying only gentle pressure.

The pivoting cutting system (twin foil ③) and integrated longhair cutter ⑤ follows the contours of your face automatically.

While shaving difficult parts of your face (e. g. under the nose or at the hairline), push switch ④ to setting «2», to lock the pivoting head at an angle.

Longhair trimmer ⑤

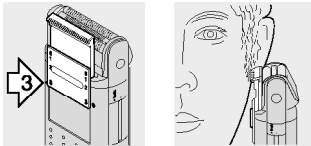

To activate the longhair trimmer, move the switch ④ to setting «3». The longhair trimmer moves upwards and allows easy and exact trimming of the sideburns.

Switching the shaver off

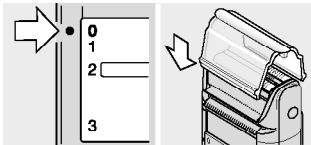

Move the switch ④ back to setting «0».

Important: After every shave, put the foil protection cap ⑨ on the pivoting head.

Switch the shaver off.

After each shave take off the triple shaving frame ⑧. Press the button ⑩ to release the triple shaving frame and pull it off.

Tap out slightly the triple shaving frame. Do not clean the twin foil ③ with the brush.

Clean the duo cutterblock ⑦ thoroughly with the brush.

Move the duo cutterblock crosswise and take it off. Brush out the entire pivoting head area, including the cutterblock base ⑥. After cleaning place the duo cutterblock back into the cutterblock base ⑥ and replace the triple shaving frame ⑧ until it clicks into place.

Approximately every four weeks clean the duo cutterblock ⑦ with Braun cleaning agents.

After every cleaning replace the foil protection cap ⑨.

The triple shaving frame and duo cutterblock are precision parts that will wear out over time. To maintain optimal shaving performance you should replace these parts when worn. This will ensure that you continue to get the close, comfortable shave you expect from your Braun shaver.

Important: Buy only original Braun spare parts, especially when replacing the cord or the triple shaving frame ⑧. When replacing the triple shaving frame look for the **BRAUN** brand. Only this way you will obtain a perfect shave.

Triple shaving frame ⑧: Remove as described under «Cleaning and maintenance». Set the new triple shaving frame on the pivoting head until it clicks into place. Handle with care.

Duo-cutterblock ⑦: Take as described under «Cleaning and maintenance». Place the new duo cutterblock into the cutterblock base ⑥ until it clicks into place.

Cleaning and maintenance

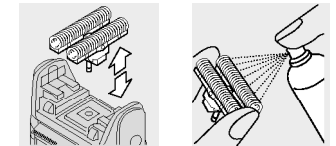
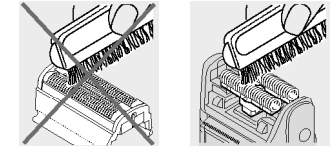
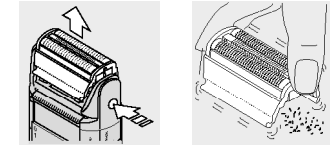

Purchasing spare parts

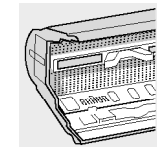

Parts for an automobile or boat



Wall holder for controlled charging

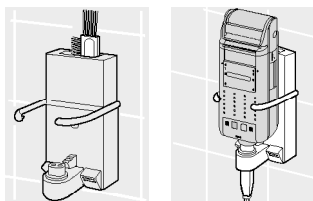

Tips for the perfect shave

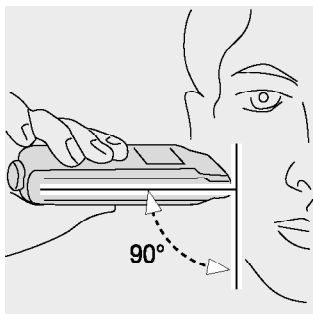

For safety reasons use only the Braun charging cord No. 5-001-687 (stated on the packaging). It is available from your dealer or from a Braun Service Centre.

Available from your dealer or from a Braun Service Centre.

Subject to change without notice.

- It is recommended to shave before washing your face; your skin is slightly swollen after washing.
- Hold the shaver at right angles (90°) to the skin.
- Stretch your skin and shave against the direction of beard growth.
- Clean the shaver after every shave (see «Cleaning and maintenance»). A poorly cleaned shaver has a reduced shaving performance.
- Use only properly functioning shaving parts.

We grant a 1 year guarantee on the product commencing of the date of purchase.

Within the guarantee period we will eliminate, free of charge, any defects in the appliance resulting from faults in material or workmanship either by repairing, or exchanging parts or exchanging the whole appliance as we may choose.

Not covered by this guarantee: damage arising from improper use (operation with incorrect current/voltage, plugging it into an unsuitable power point, kinks in the shaving foil, breakage), normal wear on the shaving foil and defects which have a negligible effect on the value or operation of the appliance.

The guarantee becomes void if repairs are undertaken by unauthorized persons and if original Braun parts are not used.

The guarantee only comes into force if the date of purchase is confirmed by the dealer's stamp and signature on the guarantee card and registration card, and if the registration card is sent to the Braun guarantee office within 4 weeks of purchase.

This guarantee extends to every country where this appliance is supplied by Braun or its appointed distributor and where no import restrictions or other legal regulations hinder or prevent service being given under guarantee.

Service under the guarantee does not affect the expiry date of the guarantee. The guarantee on parts or entire appliances which are exchanged ends when the guarantee on this appliance expires.

In the event of a claim under this guarantee, hand in the complete appliance with the valid guarantee card to your dealer, or send both to the nearest Braun Customer Service Centre.

All other claims including for damages resulting from this guarantee are excluded unless our liability is legally mandatory.

Those claims arising out of the sales contract with the vendor are not affected by this guarantee.

For UK only:

This guarantee in no way affects your rights under statutory law.

Guarantee